

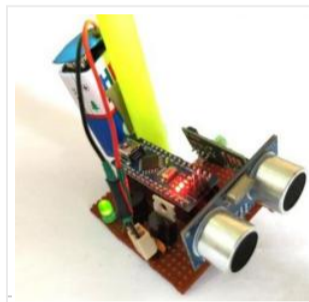

Arduino Nano Projects List in PDF offline downloadable

Posted date: [April 25, 2018](#) In: |

1. [Smart Blind Stick using Arduino](#)



Ever heard of Hugh Herr? He is a famous American rock climber who has shattered the limitations of his disabilities; he is a strong believer that technology could help disabled...

2. [DIY SWR and Power Meter](#)



Homebrew SWR and power meter First of all, this SWR meter in this article is not exactly homebrew, as I based the circuit on the schematic in the excellent book...

3. [Cyclifix: Exercise Powered Entertainment](#)



Now that the cheesy title has pulled you (Fitfix was taken and I didn't want to be sued) I'll tell you about the project, it uses a stationary exercise bike...

4. [Controlling Robot Over Bluetooth Using Xbox Steering Wheel](#)



So I'm guessing that I'm like a large amount of people on this site that are low key hoarders, keeping anything they could turn into a project or salvage for...

5. [2 Players Competition/Quiz Buzzer Box System Using Arduino](#)



Story A bit of background. My brother came to me with an odd box that a friend of his asked someone to make so that they can determine the fastest...

6. [Arduino LED Wall clock using WS2811](#)



First Hello instructables. This is my first contact with : Instructables Arduino Programmable LED's So please don't trow rocks at me for noobish mistakes. Keeping that in mind I'm waiting...

7. [Zoned Climate Control with MediaTek's LinkIt™ Smart 7688](#)



Hardware components: MediaTek Labs The MediaTek LinkIt™ Smart 7688 platform × 1 Everything ESP ESP8266 ESP-01 × 1 Arduino Nano R3 × 1 Atmel ATtiny85 × 1 DHT22 Temperature Sensor...

8. [IR Controller for Air Conditioner](#)

Search here ...

SEARCH

Our Recommended Online Courses

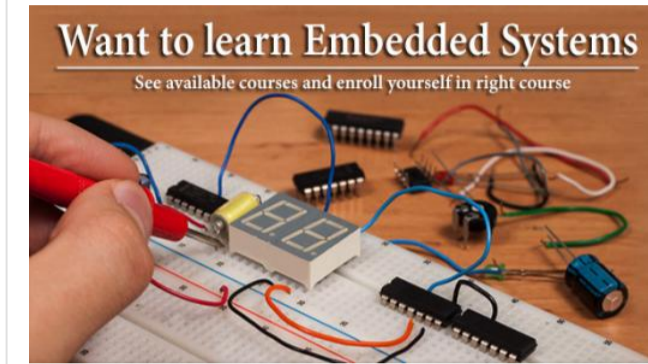

[Arduino Battery Projects](#)

[Calculator Projects](#)

[Arduino Video - Camera - Imaging Projects](#)

[Arduino Car Projects](#)

[Clock - Timer Projects](#)

[CNC Machines Projects](#)

[Development Board - Kits Projects](#)

[How To - DIY - Projects](#)

[Game - Entertainment Projects](#)

[GPS Based Projects](#)

[Home Automation Projects](#)

[Interfacing\(USB - RS232 - I2c -ISP\) Projects](#)

[Internet - Ethernet - LAN Projects](#)

[Arduino LCD Projects](#)

[Arduino LED Projects](#)

[Medical - Health based Projects](#)

[Memory - Storage Projects](#)

[Metering - Instrument Projects](#)

[Arduino Motor Projects](#)

[Other Projects](#)

[Phone Projects](#)

[Arduino PWM Projects](#)

[Radio Projects](#)

[Arduino RFID Projects](#)

[Robotics - Automation Projects](#)

[Arduino RTOS - OS Projects](#)

[Security - Safety Projects](#)

[Sensor - Transducer - Detector Projects](#)

[Sound - Audio Projects](#)

[Temperature Measurement Projects](#)



Hardware components: Atmel ATtiny85 × 1 Everything ESP ESP8266 ESP-01 × 1 Arduino Nano R3 × 1 STORY My goal is to make my window AC units more functional....

9. [OH HAI! on Windows 10 IoT Core](#)



Oh, Hai Hai ('hi') is an integration point for several stand alone smart home technologies. Hai runs on the Raspberry Pi and can be adapted to optimize electricity consumption (lighting/HVAC)...

10. [Arduino Nano: Flame Sensor With Visuino](#)

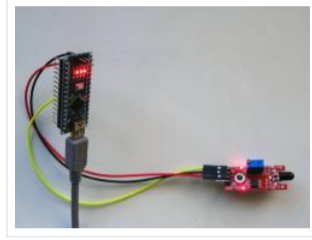

Recently somebody asked for tutorial on Infrared Flame Sensor. It took a while due to severe work overload, but finally I succeeded to make it. The Infrared flame sensors use...

11. [Stunning RGB light effects using Arduino Nano](#)



None of us could deny the fact that we would love with to play with LED's and lighting stuffs. I love to play with LED's and create attractive lighting effects....

12. [The Simple Scalar Network Analyzer](#)



After playing around with the SynthNV signal generator/power detector discussed in the previous post I realized what a useful a tool it is for RF testing. While its a terrific tool...

13. [DIY Arduino Tutorial: How to Automate Your Curtains](#)

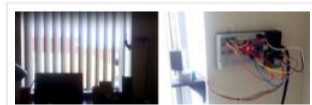

This Arduino Curtain Automation project will let you automate your curtain blinds using just an Arduino and a stepper motor. I just moved to America pursuing my higher studies. Because...

14. [Arduino Wheelchair Project: Motorized Controller Mount](#)



This was an Arduino wheelchair project we developed for Principles and Practices of Assistive Technology (PPAT) in Fall 2016 at MIT. We made an Arduino-based motorized wheelchair controller mount for...

15. [Double Servo Tester with Display](#)



This is something I've already worked on but was never really happy with the result, mainly because the potentiometre that I used was of poor quality and hence non linear and...

16. [Knock To Open Treasure Chest](#)



Preface My daughter asked me to build her a treasure chest that she could use to store her most valuable things. Obviously she demanded it to have some kind of...

17. [Humidity Display of Date, Time and Temperature](#)



Story Have you ever wanted to make your own interface that can display the time, date, along with the temperature and the humidity? Well it's a lot easier than you'd...

18. [Complete Digital Clock including Alarm and Motion Sensor](#)



I have done several designs of digital clocks for Arduino using LEDs and LCD displays, but this one is more special because I added other features like alarm and motion...

19. [How to Make an LED Scrollbar](#)

In this tutorial, we are going to build an LED Scroll Bar as shown in the image given below. The project is designed to flash Ten LED strips (by...

ONLY \$3.99
PCB Prototype

Join To Earn a \$100 Welcome Bonus

Shop Now

www.wellpcb.com

Recent Projects



Remote WiFi DHT11
Temperature an Humidity
Display

April 25, 2018



LTC3106 - 300mA Low Voltage
Buck-Boost Converter with
PowerPath

April 24, 2018



Arduino TFT Forecast Weather
Station with ESP8266

April 23, 2018



Maker's rule, the feature packed
PCB multi-tool

April 22, 2018



DC Output Solid State Relay

April 21, 2018



20. [ARDUINO MPPT SOLAR CHARGE CONTROLLER \(Version-3.0\)](#)

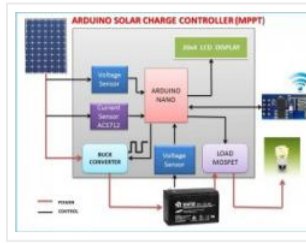

Welcome to my solar charge controller tutorials series. I have posted two versions of my PWM charge controller. If you are new to this please refer to my earlier tutorial for understanding the...

21. [Designing Electronics in Spain](#)



Hi all! With a bit of delay, here's my last work, a PICnano breadboard based on the PIC18F2550 microcontroller. I have in mind a new project and I want to...

22. [Small Arduino DMX controller](#)

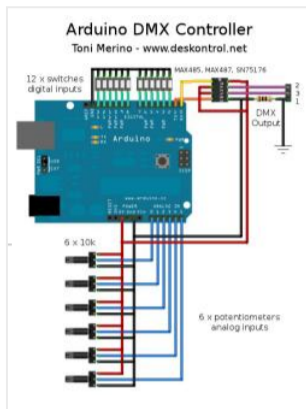

In this post we show you how to make a small and useful Arduino DMX512 controller, which can be used by example to handle a smoke machine with DMX, or as...

23. [Temperature Data Logger](#)



A temperature data logger is a portable measurement device that is able to record temperature over a defined period of time automatically. The data can be retrieved and viewed after...

24. [Arduino project: USB foot-operated mouse switch](#)



This foot pedal plugs into the Arduino case, which then plugs into your PC via a microUSB cable. Arduino microcontrollers can easily be used to power fun projects like robots and even...

25. [How to make a Arduino LED Scroll Bar](#)



Today I want to make a LED scroll bar as the above picture shows. Ten LED strips can flash in different effects by using a control board. Required components: LED...

26. [Arduino based Bi-color LED Matrix Flappy Bird Game](#)



We have built quite a few projects using the Bi-color (Red and Green) LED Matrix Driver Module kits from jolliFactory and have published them as instructables here. Each of these...

27. [Arduino Laser Tag – Duino Tag](#)



Duino tagger - General introduction Duino tag is a laser tag system based around the Arduino. Finally a laser tag system that can be tweaked, modded, and hacked until you have...

28. [DIY wattmeter with an Arduino](#)



DIY wattmeter with an Arduino It is difficult or sometimes even impossible to measure power and energy with ordinary multimeters. To carry out such a measurement reliably and accurately, a...

29. [Arduino car LCD display](#)



Here is a project I made a couple of years ago for my father's car. The original dashboard's info-panel, which displayed current time, date, and temperature, was working only partly...

30. [Adventures in Moteino: Remote Temperature Monitor](#)

Introduction What every new system design has in common these days is wireless. Like bacon, it just makes everything better. Put a sensor wherever, read



it from somewhere else. Put...

31. [Arduino Project # 1 – Make an Ultrasonic Distance Calculator](#)



Arduino Project – The distance calculator I have been playing with Arduino (micro-controller) for about 2 years now and I am becoming more and more passionate about circuits. For those...

32. [ARDUINO SOLAR CHARGE CONTROLLER \(Version 2.0\)](#)



One year ago, I began building my own solar system to provide power for my village house. Initially I made a LM317 based charge controller and an Energy meter for monitoring...

33. [Make an Ultrasonic Distance Calculator](#)



Arduino Project – The distance calculator I have been playing with Arduino (micro-controller) for about 2 years now and I am becoming more and more passionate about circuits. For those...

34. [Arduino project: Stereo Peak Program Meter using arduino](#)



Previously, we introduced the Arduino's analog-to-digital converter (ADC) in detail, looking at successive-approximation A-D conversion and how it's the best compromise between speed and cost. This time, we start putting...

35. [Temperature Data Logger](#)

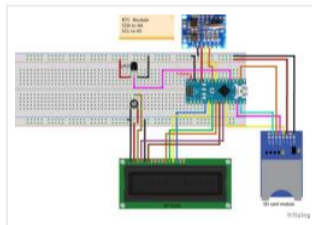

A temperature data logger, is a portable measurement device that is able to recording temperature over a defined period of time automatically. The data can be retrieved and viewed after...

36. [Double RC servo tester with OLED display](#)



This is something I've already worked on but was never really happy with the result, mainly because the potentiometre that I used was of poor quality and hence non linear and...

37. [Rocket Brand Studios Medium Tank using arduino](#)



This is the assembly instructions for the Medium Tank from Rocket Brand Studios. This is a great little robot kit, and can be purchased as a complete kit or as...

38. [Hackabot Nano: Compact Plug and Play Arduino Robot](#)

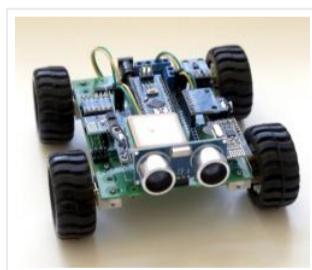

What? Why? Hackabot Nano is a very compact many-in-one plug-and-play Arduino Robot. The goal is to help everyone build a feature-rich robot without all the messy wiring. You simply connect...

39. [Build your own Arduino for under £10](#)



How to make a stripboard Arduino clone, AKA the verduino. Once a project is past the prototype stage there is no need to use a complete Arduino, even with the...

40. [Cheap Arduino Controled Yogurt Maker](#)



These days I was reading an interesting post on how to make yogurt "by the gallon" (<http://www.instructables.com/id/Yogurt-By-The-Gallon/>). One thing needed was to maintain a rather constant temperature of 43°C (110°F),...

41. [Arduino BlinkyBall Project](#)



I frequent a blog called hackaday.com which featured a project by "Nikolai", it was a 10cm LED ball that used shift registers. It seems like a really fun project to...

42. [ARDUINO MPPT SOLAR CHARGE CONTROLLER \(Version-3.0\)](#)

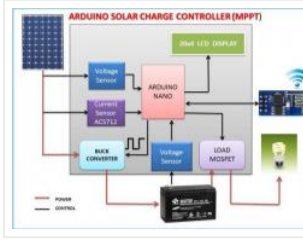

Welcome to my solar charge controller tutorials series. I have posted two version of my PWM charge controller. If you are new to this please refer my earlier tutorial for understanding the...

43. [PICnano breadboard based on PIC18F2550](#)



Hi all! With a bit of delay, here's my last work, a PICnano breadboard based on the PIC18F2550 microcontroller. I have in mind a new project and I want to use an...

44. [Colorful Countdown Clock for tight timeline management using Arduino](#)



This is a funny looking clock that has that displays time on relatively large 32x16 Bi-Color LED Matrix. It includes also a countdown counter that I find very useful in...

45. [Arduino Nano based Microbot](#)

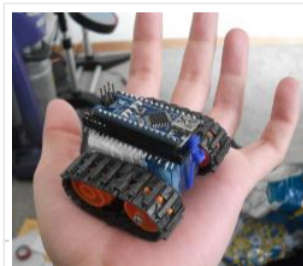

This instructable was created to be entered in the Robot Challenge. If I win, the parts will of course, go into robots like this one. Notes on how to include some...

46. [Arduino Masterclass Part 1: Make your own hardware](#)



The world is going nuts over the Raspberry Pi single-board computer (SBC) for being a whole system under \$50. In reality though the Pi isn't actually the cheapest computing device...

47. [Arduino Wall Lamp](#)



So, I have always wanted a nice lamp by the side of my bed, Something simple with out any buttons. Of course this would mean it had to be wireless. I also wanted to use...

48. [Intervalometer for Sony NEX 5n](#)



This intervalometer used infrared LED To built intervalometer you need: Arduino Nano (or Arduino-compatibility). I used Nano V3 Serial LCD Joystick Module IR Led and resistor ~200 Ohm Switch Push...

49. [Haptic Proximity Module \(HPM\) for Low Vision users](#)

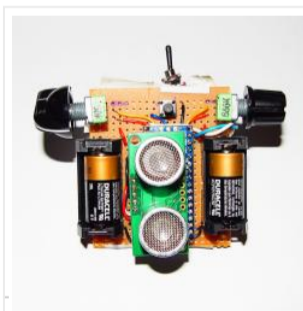

The Haptic Proximity Module (HPM) seeks to enable people with low vision, or other vision impairments, to engage with their direct surroundings through vibration feedback from a range detector, and...

50. [LED Dawn / Sunrise Alarm Clock, Nightlight & Security Light – Arduino Compatible](#)



As the nights gradually lengthened in autumn 2011, I discovered the joys of Arduino and thought that it would be a great way to implement something that I have wanted...

51. [Playing Wave file using arduino](#)



This is a simple circuit to play wav files using arduino Nano V3.0 ,it consist from 4 buttons ,each one play specific wav file loaded to SD card. Step 1:...

52. [Nano Prototyping Shield](#)

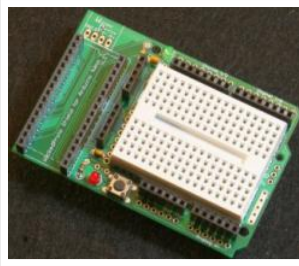

Nano Prototyping Shield description: Adds prototyping space and the ability to connect regular shields to the Arduino Nano. Nano Prototyping Shield specification: Nano Prototyping Shield pinout: Note: No I/O...

53. [PCB on a Box using Arduino Board](#)



Sorry, but I hate cleaning windows, is one of my unfinished business as usual, but I had to do (at least) every time I wanted to etch a circuit board...

54. [Barista championship brewing stopwatch • Introduction using arduino](#)



Upon the needs of the (2014) World Barista Championship Rules and Regulations, an adequate and precise time measuring is needed during the competition. These measurements are usually done by regular...

55. [Sensor Arduino Lab 2013](#)

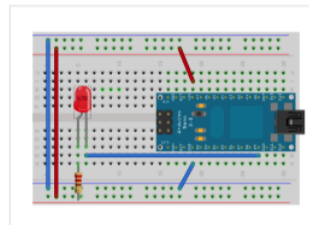

This lab most recently revamped by Edgar Berdahl and Wendy Ju. Chris Carlson, possibly Bill Verplank, and others have likely contributed. For this lab you need your Satellite CCRMA kit,...

56. [DIY handmade Hexapod with arduino \(Hexdrake\)](#)



Hello, I'm David and in this instructable I'll show how I made this hexapod whose name is Hexdrake. Since I was 16 I became interested in electronic and later in...

57. [Build Your Own Sourcemeter](#)

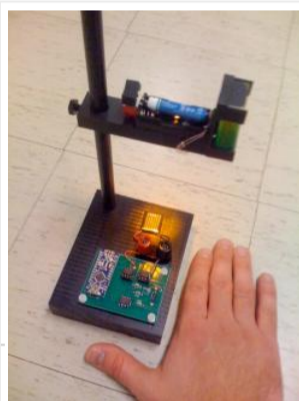

This is an explanation and set of building plans for a USB-powered sourcemeter with a personal computer interface. The sourcemeter uses an open-source Arduino microprocessor and the user interface uses the open-source Processing...

58. [Proximity sensing mouse wheel scroller using Arduino](#)



List of tools: 1. Exacto 2. Arduino Nano / USB chord (Mini-B) 3. Dremel / Drill 4. Paper & Pencil 5. Sharp IR Sensor (2Y0A21 F) 6. Hot glue gun...

59. [ARDUINO SOLAR CHARGE CONTROLLER \(Version 2.0\)](#)



One year ago, I began building my own solar system to provide power for my village house. Initially I made a LM317 based charge controller and an Energy meter for monitoring...

60. [Arduino based Bi-color LED Matrix Pong Game](#)



We have created two game project instructables so far using the jolliFactory Bi-color LED Matrix Driver Module D.I.Y kits we designed. This LED Matrix module is designed to be chain-able...

61. [Build your own 4x4x4 RGB LED Cube using arduino](#)



LED Cubes are awesome. The first one I created was a 8x8x8 blue led cube. It still works like a charm. But being able to display every colour in the...

62. [Arduino based Bi-color LED Matrix Audio Spectrum Visualizer](#)

After we came up with the Bi-color LED Matrix Driver Module kit, we have been looking around for interesting projects to work with it. You may be interested in some...

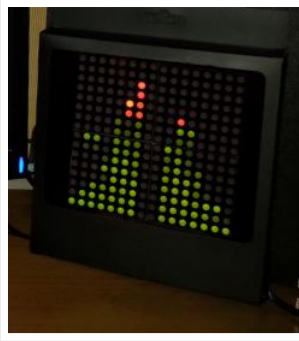

63. [ARDUINO WIRELESS HOME SECURITY SYSTEM](#)



In this project I will discuss how you can make a cheap wireless home security system. Though during starting of this project the main objective was only for security alarm but...

64. [NFC Ring Lock Box using Arduino](#)



Hi everybody! Welcome to my first instructable! I apologize in advance for my poor level in English. In this step-by-step guide I am going to teach you how to build...

65. [SOLAR POWERED ARDUINO WEATHER STATION](#)



In country like India most of the people are dependent on agriculture. For effective planning in agriculture weather forecast is of utmost importance. So farmers are always interested in the Weather Forecasts. As...

66. [LEGO T-Intersection LED Traffic Light using Arduino](#)



Video not playing? See it on YouTube:
<http://www.youtube.com/watch?v=q0tiiWwC6Zo>
Background Every Christmas we set up a large LEGO train layout in a section of the living room. This year, I ended...

67. [Arduino Watch with Nokia 3110 screen](#)



My goal for this project is to make a watch with selectable dials, stopwatch and millidays. This idea started with an April's fools prank about metric-time.
(<http://www.youtube.com/watch?v=K35xG1buyFA>) First I wanted...

68. [Pimp My Zoomobil using Arduino](#)



I recently put together the Playmobil Zoomobil for my kids. As I was busy snapping all the pieces together, I became more and more convinced that this cart had been...

69. [Arduino powered Solar Battery Charger](#)



The following design is for a Solar battery charger ran by an Arduino Nano. It can handle a standard lead acid 12V battery, like for a scooter or a car....

70. [Arduino-powered LED Clock](#)

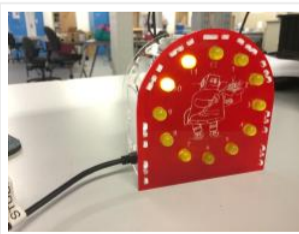

A fun, simple LED clock, that will give you the time to the nearest half hour using single-color LEDs. Parts needed are as follows: Arduino Nano 400 tie-point Breadboard Ribbon...

71. [Gas detector / indicator \(USB powered\) with arduino](#)



ArduSniffer This Instructable shows how to build a gas detector / indicator using an arduino. The finished product is USB powered and displays the amount of detected gas on a...

72. [BoB the BiPed](#)

Did you buy an arduino after seeing all the cool instructables and now you tired of just making LEDs blink? Are you envious of all the cool walking robots people...



73. [Pet Curfew: An Arduino Controlled Pet Door](#)



The Problem: You want to restrict the time when your pet is allowed to go outside. This could be because the neighborhood is not safe for your cat or small...

74. [Simple 18dof Hexapod, Arduino nano \(optionally with pololu maestro\)](#)



Hello, Here is a simple hexapod that can be built by hand very quickly. The mechanical design is not great, but it is very much in the KISS (keep it...

75. [Arduino Power, RGB + White LED, Bluetooth controllable, Floor lamp](#)



A couple of mounts ago i order a 1M long WS2801 RGB led strip, just for fun. I took me a while to get the strip working with my Arduino....

76. [Arduino based programmable load](#)



Summary: I designed an electric load. Using an Arduino Nano, the load can be programmed, and the voltage and current are measured. You can set a constant current (CC), a constant power (CP), or a...

77. [PIDDYBOT – A Self Balancing Teaching Tool](#)



After I built the tiny balancing robot using an IR sensor for stabilization, there was a comment on the youtube video about how it would be a good thing for kids to...

78. [Typewriter: generative stories about killed journalists](#)



On Journalism #2 Typewriter" is a typewriter installation of Julian Koschwitz, which purpose is to remember journalists who got killed in the past 20 years. The installation writes generative stories about all journalist...

79. [A Small GPS Arduino Watch / Clock](#)



Another Arduino GPS Project – Mini GPS Device Garlow is a mini GPS Watch that is based on the Arduino Nano board. It's not really that "mini" compared to other...

80. [Make a Mini Arduino programmable 4 channel DC-DVM](#)

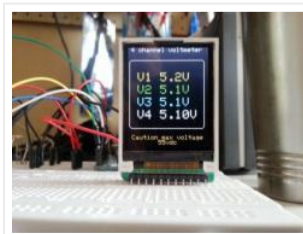

This Instructable will teach you how to use the Arduino Analog ports. Digital Voltmeters (DVMs) are a special case of Analog to Digital converters- A/DCs.- they measure voltage – and...

81. [Arduino ultrasonic range finder](#)



Hello, in this project i want to show and explain you a range sensor with ultrasonic and a 20x04 lcd screen. I wrote the code for this project myself and...

82. [*duino Keg Temp Monitor, or the Quest for the Perfect Pint](#)



I was looking for a project that combined my three favorite things – working in my shop, building cool stuff for my bar and of course, drinking beer. After a couple of...

83. [Arduino Chessclock](#)



I could not find instructions on a good Arduino chess clock so instead I built my own which I will describe here. Step 1: Parts list [box color="#985D00" bg="#FFF8CB" font="verdana"...

84. [Arduino-Radio Controlled Hydrogen Blimp](#)



The blimp is controlled by a transmitter on the ground, operated by a human. There are three control levers—one for each motor, and one for the servo that rotates...

85. [Arduino Processing Audio Spectrum Analyzer](#)



In this Instructable I am going to show how to make a program in Processing that analyzes sound on your computer and sends data to an Arduino that controls an...

Tweet 0 Like

< Previous

Project Ratings:

★ ★ ★ ★ ★ (No Ratings Yet)

Related posts

USEFUL RESOURCES

- [Arduino Complete Projects List](#)
- [Arduino UNO Projects List](#)
- [Arduino Offline Projects PDF](#)
- [Arduino Mega 2560 projects](#)
- [Arduino Tutorial Courses Videos](#)
- [Esp8266 Arduino Projects List](#)
- [Arduino Zero Projects List](#)
- [Arduino Nano Projects List](#)
- [ESP32 Arduino Projects List](#)

FACEBOOK

Be the first of your friends to like this

ADVANCE SEARCH

Select Category:
 ▼

Enter Search Terms:

LAST VISITED:

- How to Build a LM35 Temperature Sensor Circuit
- Probably the Cheapest WIFI Computer in the World (ESP8266+LUA)
- Dual Channel H-Bridge Motor Driver Shield